



Emergency Luminaire Surface Ceiling / Wall

IP44

Class 1 

Ora Series

Downlighter features	Supply voltage	Lumens (mains mode)	Part No.
 MM3 SPECTO-XT	220-240V AC 50/60 Hz	953 1191 1553	ORAXT953W ORAXT1191W ORAXT1553W
 MM3 		953 1191 1553	ORADL953W ORADL1191W ORADL1553W

Dimensions

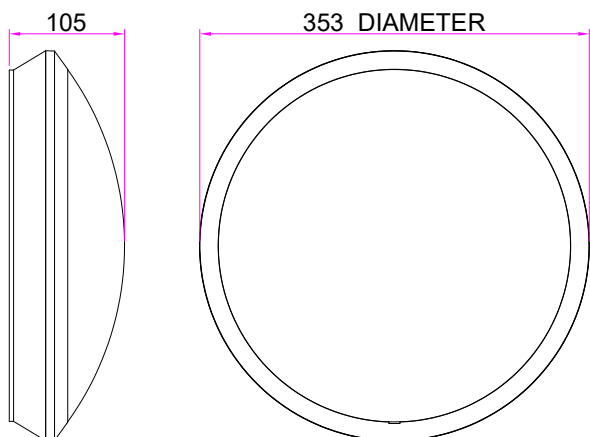

Connections

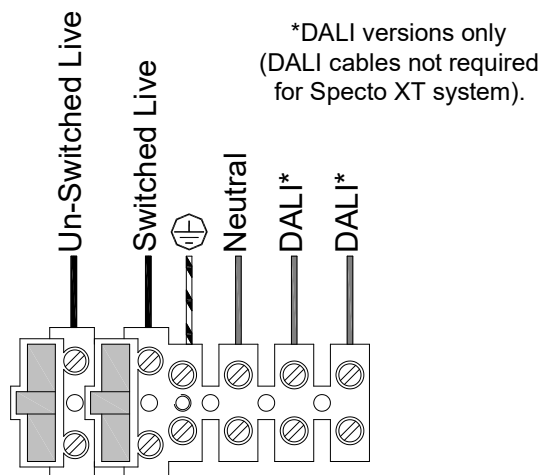

Installation Method - Surface Mounted

1

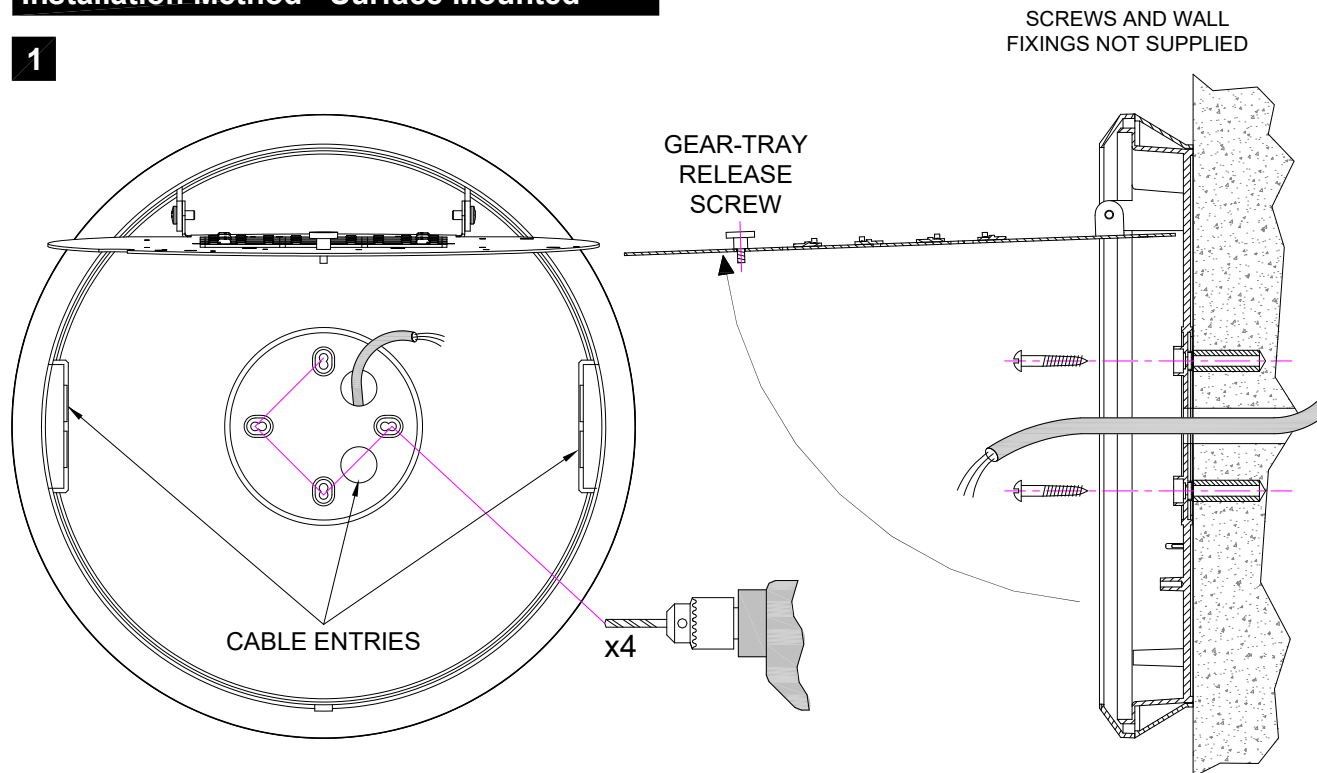

NOTICE TO CONTRACTOR - PLEASE PASS THIS LEAFLET TO THE END-USER.

2

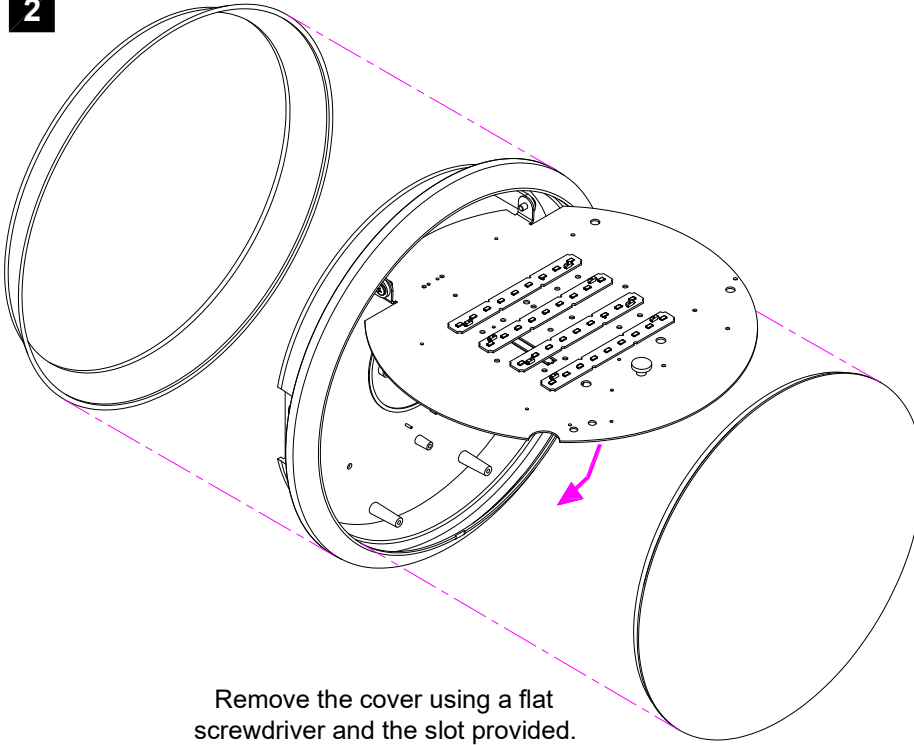

Remove the cover using a flat screwdriver and the slot provided.

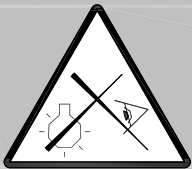

Do not stare at operating LED lightsource. It may be harmful to the eyes.

Recessed option.

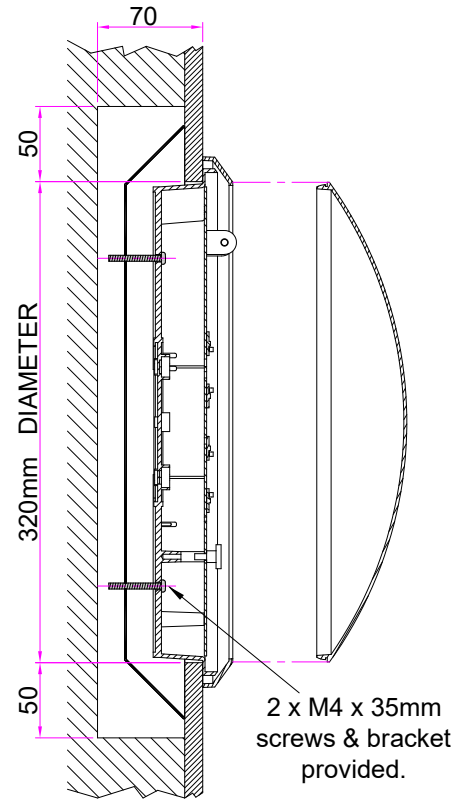

Loosely fix recess bracket before inserting luminaire into recess. Then tighten up the screws.

Cleaning Instructions

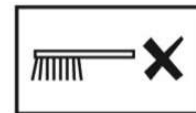

Operation and Maintenance

Continual operation at mains voltages in excess of the rated voltage will reduce LED and expected gear life. This luminaire uses plastic components in its construction and when installed in environments containing chemicals, degradation may occur. Please contact our Technical Department for advice.

Modifications

Philip Payne products should not be modified. Any modification may render the product unsafe and will invalidate any Safety/Approval marks. Philip Payne will not accept any responsibility for any modified products or for any damage caused as a result of their modification.

Monthly and Annual Tests

Monthly and Annual tests should be carried out in accordance with BS EN 50172:2004, 7.2. Testing can be carried out by using a sub circuit isolator or by switching off the lighting circuit at the circuit breaker (not for AutoTest or DALI versions). Battery pack shall be replaced if the specified 3 hour duration is not met. For replacement battery pack contact Philip Payne Ltd. The light source of this luminaire is not replaceable; when the light source reaches its end of life the whole luminaire shall be replaced.



Philip Payne Ltd
 A SUBSIDIARY OF F.W. THORPE PLC
 Thornhill Road, Solihull, B91 2HB, England.
 Tel: 0121 705 2384
 Fax: 0121 711 2469
 e-mail: mail@philippayne.co.uk
 Website: http://www.philippayne.co.uk
 Philip Payne Ltd registered in England No. 1361523



ISO9001
FM55077



21LFT103_1