





Emergency Downlighter Surface Ceiling

IP20

Class 1



SPRITE 880/885 Series

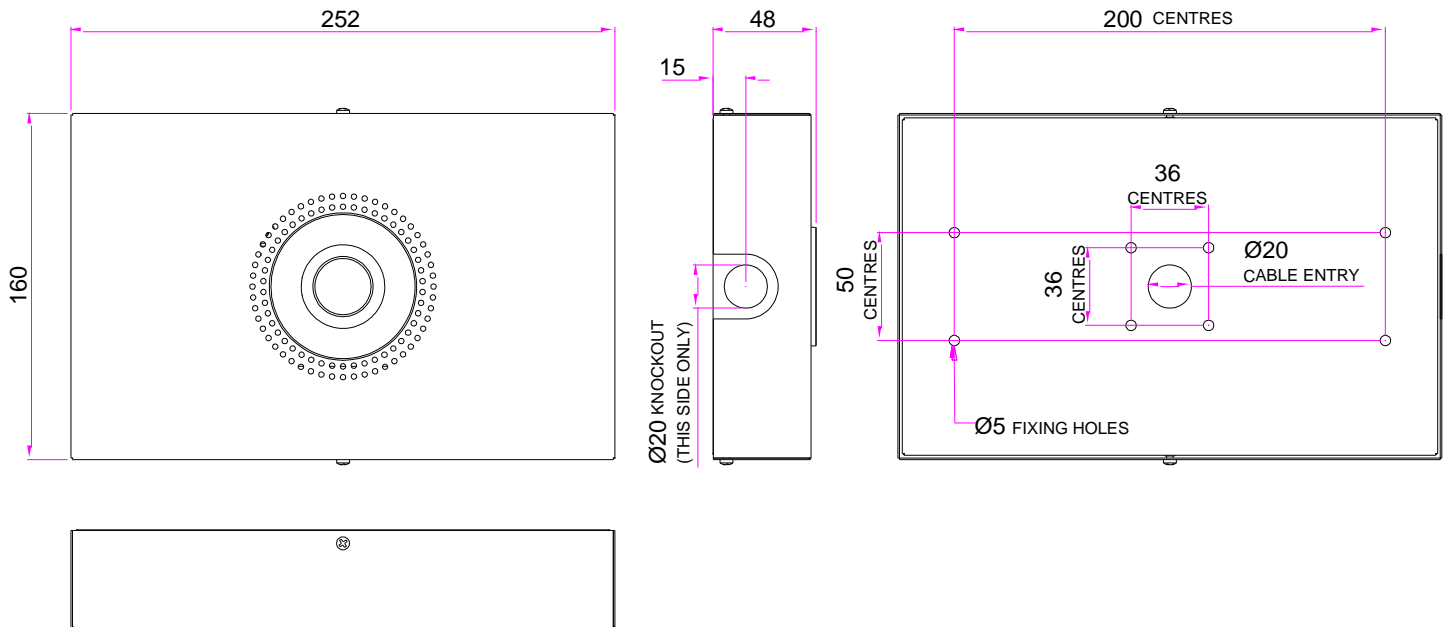

Downlighter features	Supply voltage	Maximum luminaires on a Type B, 10A circuit breaker	Part No.
 NM3 SPECTO-XT	220-240V AC 50/60 Hz	90 luminaires	SPRA880XT
 NM3 SPECTO-XT	220-240V AC 50/60 Hz	90 luminaires	SPRC880XT
 NM3 SPECTO-XT	220-240V AC 50/60 Hz	90 luminaires	SPRE880XT
 NM3 SPECTO-XT	220-240V AC 50/60 Hz	90 luminaires	SPRT885XT

Dimensions



Do not stare at operating lamp.
It may be harmful to the eyes.

Connections

 NM3
 Specto-XT

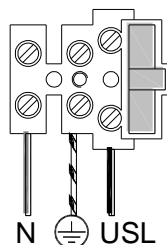

Installation Method

1

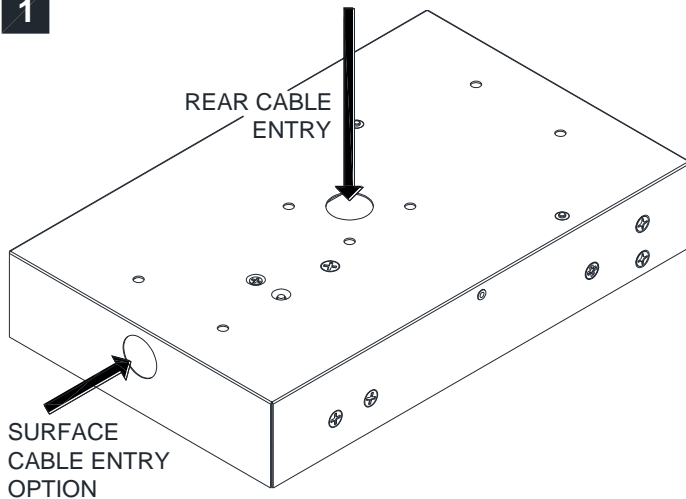

2

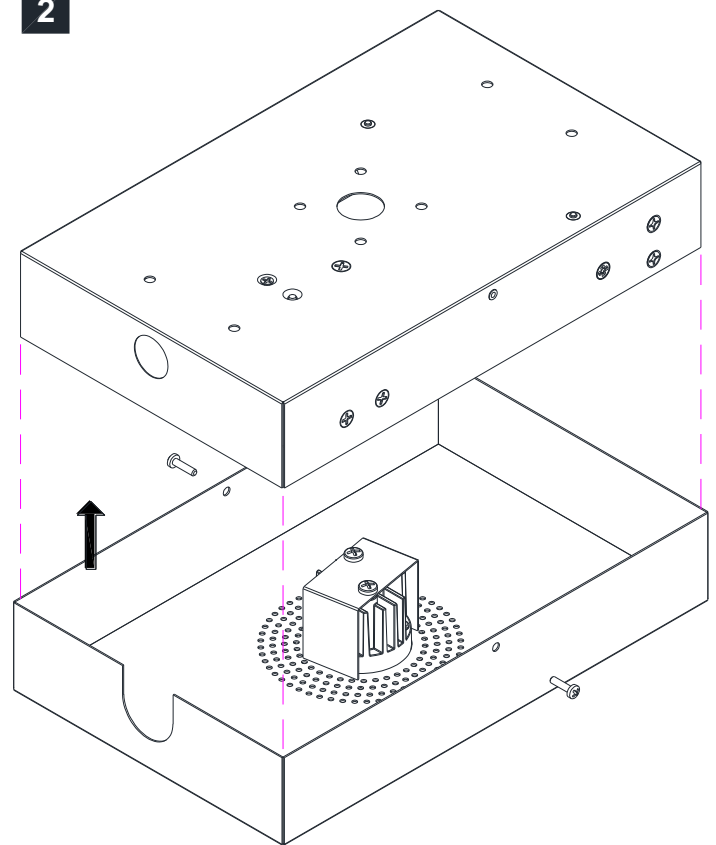

Cleaning Instructions

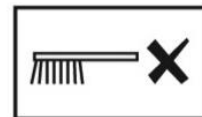

Operation and Maintenance

Continual operation at mains voltages in excess of the rated voltage will reduce LED and expected gear life.

This luminaire uses plastic components in its construction and when installed in environments containing chemicals, degradation may occur.

Please contact our Technical Department for advice.

Modifications

Philip Payne products should not be modified.

Any modification may render the product unsafe and will invalidate any Safety/Approval marks.

Philip Payne will not accept any responsibility for any modified products or for any damage caused as a result of their modification.

Monthly and Annual Tests

Monthly and Annual tests should be carried out in accordance with BS EN 50172:2004, 7.2.

Testing can be carried out by using a sub circuit isolator or by switching off the lighting circuit at the circuit breaker (not for AutoTest or DALI versions).

Battery pack shall be replaced if the specified 3 hour duration is not met.

For replacement battery pack contact Philip Payne Ltd.

The light source contained in this luminaire shall only be replaced by the manufacturer or his service agent or a similar qualified person.

Important-Safety

**Before carrying out any servicing on this luminaire, ensure that the mains supply is fully isolated.
Disconnect luminaire before insulation testing of the installation.**



Philip Payne Ltd

A SUBSIDIARY OF F.W. THORPE PLC
Thornhill Road, Solihull, B91 2HB, England.

Tel: 0121 705 2384

Fax: 0121 711 2469

e-mail: mail@philippayne.co.uk

Website: http://www.philippayne.co.uk

Philip Payne Ltd registered in England No. 1361523



ISO9001
FM55077



21LFT085_2