

300SD

Double Sided Edgelit Exit Sign

Class
1

IP
54

Philip Payne

FEATURES

Model	Features	Supply voltage	Maximum luminaires on a Type B, 10A circuit breaker	Part No.
Maintained	MM3	220-240V AC 50/60Hz	90 Luminaires	300SDLM
Self Test	MM3 Auto Test	220-240V AC 50/60Hz	90 Luminaires	300SDYL
DALI	MM3 DALI	220-240V AC 50/60Hz	90 Luminaires	300SDDL
SPECTO-XT	SPECTO XT	220-240V AC 50/60Hz	90 Luminaires	300SDXT
Central Supply		220-240V AC 50/60Hz 176-264V DC	30 Luminaires	300SDLA
Central Supply DALI	DALI	220-240V AC 50/60Hz 176-280V DC	30 Luminaires	300SDDA

WARNING



Do not stare at operating lamp. It may be harmful to the eyes.

EXIT SIGN DIMENSIONS

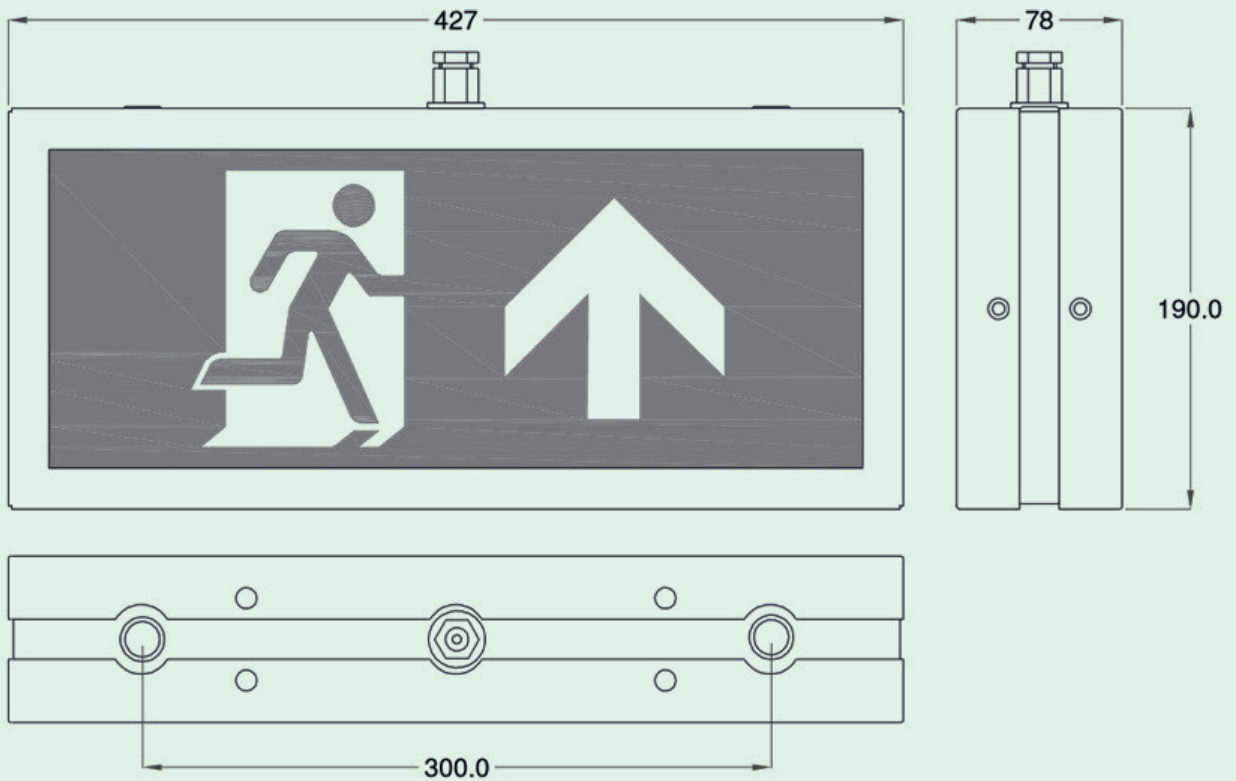

IMPORTANT-SAFETY

Before carrying out any servicing on this luminaire, ensure that the mains supply is fully isolated. Disconnect luminaire before insulation testing of the installation.

SUPPLY CONNECTIONS

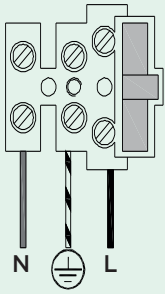
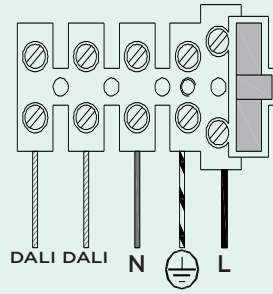
CENTRAL SUPPLY
AND SPECTO XTCENTRAL SUPPLY
DALI

SELF TEST

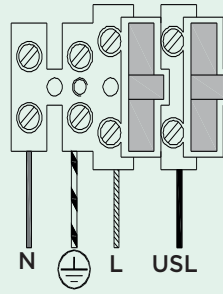

DALI

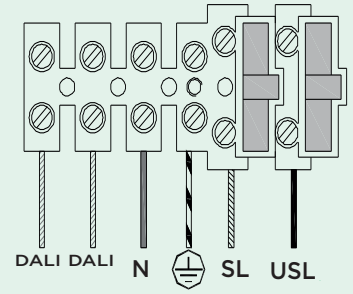

BASIC INSULATION IS MAINTAINED BETWEEN THE LV SUPPLY AND CONTROL CONDUCTORS ON THIS LUMINAIRE.

GENERAL INSTALLATION METHOD

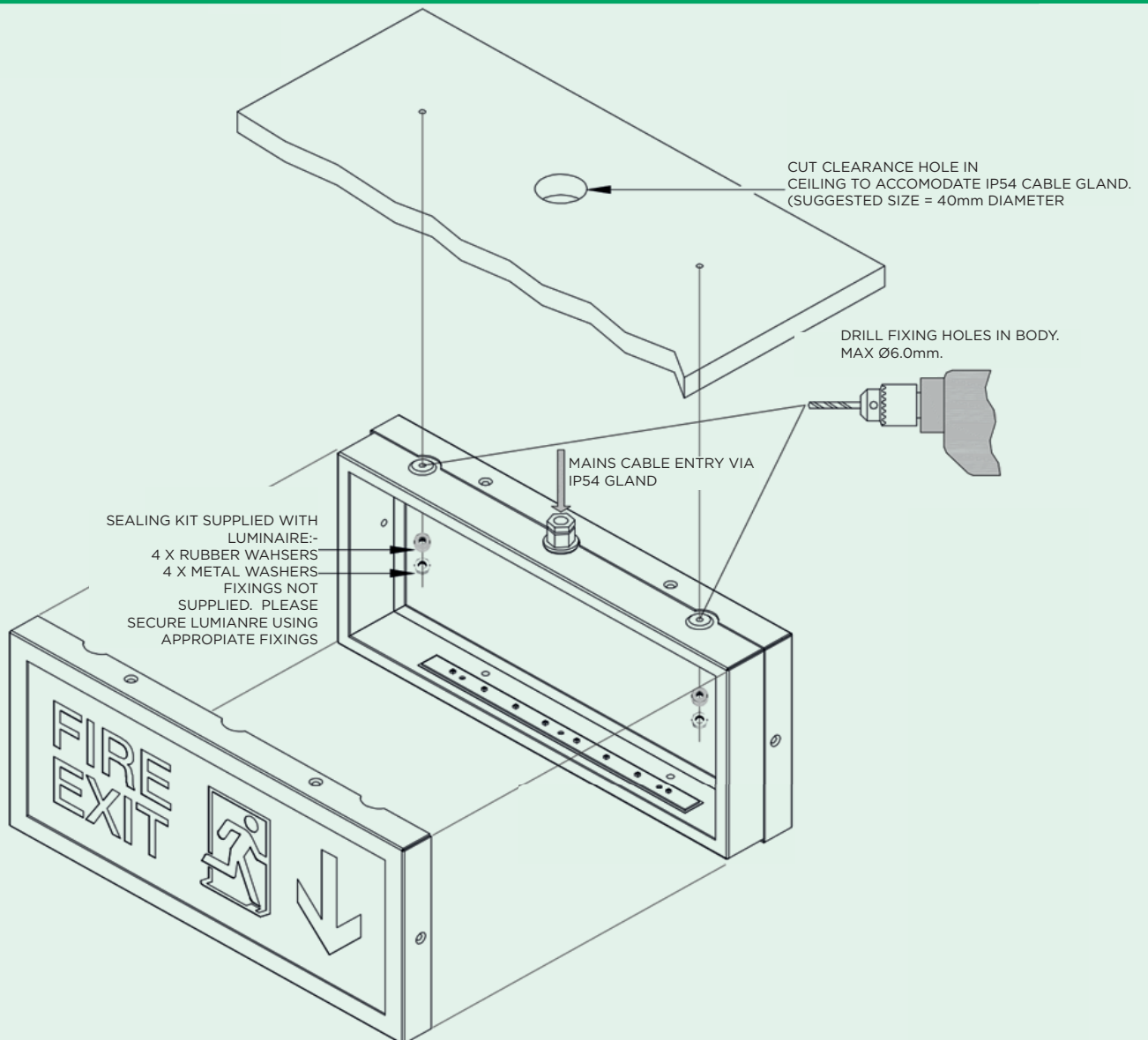

COVER/ LEGEND REMOVAL

- A. USE KEY PROVIDED
- B. SECURE LEGEND PANEL WITH HAND
- C. LOCATE TOOL UNDER EDGE OF FRAME
- D GENTLY PULL BACK ON THE TOOL TO REMOVE FRAME, LEAVING LEGEND FREE.
- E. LIFT LEGEND TO ACCESS GEAR TRAY.

LED STATUS INDICATION

Operation	Led Status
Normal mode	Green LED- ON
Commissioning	Green LED- ON
Function test	Green LED- Fast Flash
Duration test	Green LED- Slow flash
Lamp fault/open circuit/short circuit	Red LED - ON
Battery fault	Red LED - Slow flash
Charge fault/Circuit fault	Red LED - Fast flash
Emergency mode	LED OFF
Identification	Red/Green LED - Slow flash

FAULT RECTIFICATION SEQUENCE

1.Fault Identification	Slow Red Flash = Battery Fault	Permanent Red = Lamp Fault	Charge Fault
2. Take Remedial Action	Check Lamp/ Replace Lamp	Check Battery/ Replace Battery	Check Module/ Replace Module
3. Reset Unit/ Check Status	Switch Luminaire unswitched mains off / on For Specto-XT use the Specto-XT Programmer to check status of luminaire.		
4. Automatic Reset	Philip Payne AutoTest automatically resets the module to confirm rectification of fault. The device then reverts to standby mode if the fault has been cleared or returns to fault indication if fault persists. For Specto-XT use the Specto-XT Programmer to initiate function/duration test. The luminaire will pend the test until the battery is sufficiently charged. The test status can be retrieved using the Specto-XT Programmer (please leave at least 60 seconds between test initiation and reading status).		

IMPORTANT

To prevent lamp damage and false triggering of fault status please note the following :-

- Ensure LED's are connected correctly to the luminaire prior to applying power.
- Do not interrupt unswitched supply during self-commissioning period.
- Please allow 51 hours for charge, discharge, charge cycle.

Fitting Reference:		Installation Date:										Location:
MONTH	TEST	EXAMPLE	1ST YEAR	2ND YEAR	3RD YEAR	4TH YEAR	5TH YEAR	6TH YEAR	7TH YEAR	8TH YEAR		
	1. Funtional	PASSED										
	2. Funtional	PASSED										
	3. Funtional	PASSED										
	4. Funtional	PASSED										
	5. Funtional	PASSED										
	6. Funtional	PASSED										
	7. Funtional	FAILED- REPLACED LAMP HEAD										
	8. Funtional	PASSED										
	9. Funtional	PASSED										
	10. Funtional	FAILED- REPLACED BATTERY										
	11. Funtional	PASSED										
	12. 3-Hour Duration	PASSED										

Each month, or more frequently if a fault is identi fied, we recommend the installation is checked for status of L.E.D.'s. Corrective action if necessary should be taken and recorded on the above form.

Follow good practice as laid down in relevant legislation such as BS 5266.

TO RESET AFTER A FAULT - SWITCH LUMINAIRE UNSWITCHED
 MAINS OFF / ON.
 SLOW RED LED FLASHING = BATTERY FAULT
 PERMANENT RED LED = LAMP FAULT

CLEANING INSTRUCTIONS

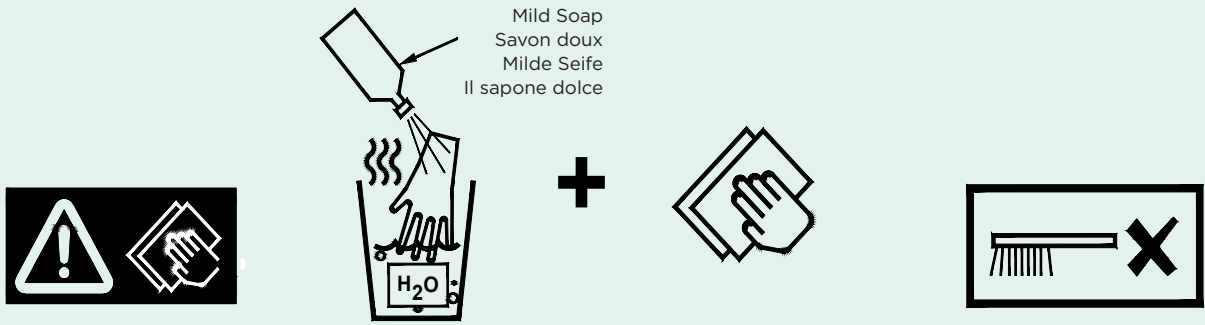

INFORMATION

Operation and Maintenance

Suitable for indoor use.
Ambient temperature 25°C.
Continual operation at mains voltages in excess of the rated voltage will reduce LED and expected gear life.
This luminaire uses plastic components in its construction and when installed in environments containing chemicals, degradation may occur.
Operation outside intended / stated parameters may cause a hazard, and in an extreme case, for example water ingress to electronic circuits, may cause a fire.
Please contact our Technical Department for advice.

Modifications

Philip Payne products should not be modified.
Any modification may render the product unsafe and will invalidate any Safety/Approval marks.
Philip Payne will not accept any responsibility for any modified products or for any damage caused as a result of their modification.

Monthly and Annual Tests

Monthly and Annual tests should be carried out in accordance with BS EN 50172:2004, 7.2.
Testing can be carried out by using a sub circuit isolator or by switching off the lighting circuit at the circuit breaker (not for AutoTest or DALI versions).
Battery pack shall be replaced if the specified 3 hour duration is not met.
For replacement battery pack contact Philip Payne Ltd.
The light source contained in this luminaire shall only be replaced by the manufacturer or his service agent or a similar qualified person.



Philip Payne Ltd, Thornhill House, Thornhill Road, Solihull, B91 2HB
+44 (0)121 705 2384 | mail@philippayne.co.uk | www.philippayne.co.uk



KM587259
BS EN ISO 60598-2-22



FM-55077

